

Cell Bridge: A Signal Transmission Element for Networked Sensing

A.Okada, Y.Makino, and H.Shinoda

Department of Information Physics and Computing,
Graduate School of Information Science and Technology,
The University of Tokyo, 7-3-1 Hongo Bunkyo-ku Tokyo, 113-8656, Japan

okada@alab.t.u-tokyo.ac.jp, yasutoc@alab.t.u-tokyo.ac.jp, shino@alab.t.u-tokyo.ac.jp

Abstract: In this paper, we propose a novel communication system in networked sensing field. The network is constructed by combining multiple two-dimensional areas called “cells” where signals propagate with communication elements called “cell bridges” and requires neither radio technologies nor long wirings. The property of the proposed system enables us to construct high-density sensor sheet on various materials. We show the physical layer and the data link layer of the cell bridge. We developed a prototype cell bridge based on CMOS technology. The experimental results showed the proposed system is capable of high-speed communication on stretchable clothes.

Keywords: networked sensing, cell bridge, two-dimensional communication, wearable computing, wireless, stretchable sensor sheet, pressure sensor array

1. Introduction

In these years, the demand of the network system where various elements connect each other has been growing along the progress of the network technology. Networked sensing, a kind of the sensing method with those network systems, is getting much attention in many fields: weather/environment observation, manufacturing and other ubiquitous applications inside/outside of the house. The basic issues on synchronization [1,2], broadcasting [3] and coverage [4] have been already studied intensively. One of the problems that have not been discussed in networked sensing field is how to physically construct a high-density network on floors, wall, clothes, desks, and other surfaces. Radio technology [5, 6] is supposed to be a solution for it. But there are many cases in which RF is impractical in terms of the energy consumption, power supply, and the acquired throughput.

In this paper, we propose a novel signal transmission system in order to solve those problems. In this system, the network is constructed by “cell bridge” and “cell.” This approach is one form of the two-dimensional communication [7] methods. A cell bridge is a communication chip that can transmit and receive electric signals through cells. A cell is a two-dimensional medium where the cell bridge transmits signals. Many kinds of conductive materials like rubber and fabric are available for it.

The cell bridge network is easily expanded by the iteration of the connection as Fig. 1 shows. The signal paths are dynamically formed like the lines shown in Fig. 1. The communication among the external elements: sensors, PC, or other peripherals, is carried out via multi-hopping through multiple cell bridges. In this network, there is no

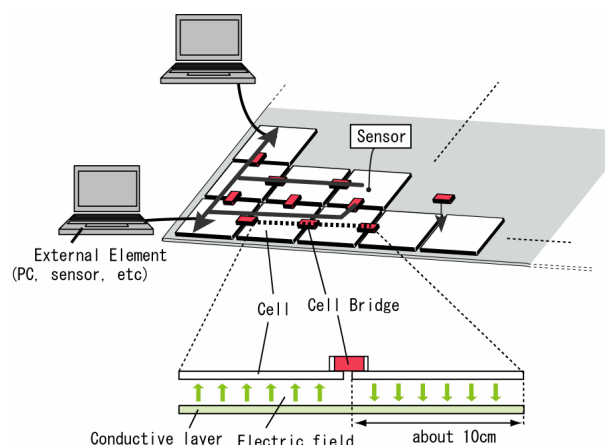

Fig. 1 The concept of the network constructed by cell bridges and cells (upper). Packets are transferred by multi-hopping between the external elements. The proposed system can be a flexible pressure sensor sheet as well as communication sheet, because cells can be endowed with a pressure sensing function. The lower figure illustrates the electric field in a cross-section of the communication layer. Electromagnetic energy is confined in the communication layer.

central station. Network operations such as routing and packet flow control are performed in a distributed and cooperative manner. The relative positions among the cell bridges are fixed and the coverage of each cell bridge is defined. Therefore the problems of collision avoidance and path setting are simpler compared to the network with the mobile sensor elements, which enables us to realize a tiny cell bridge that provides effective communication.

The signal to the neighbor cell bridge is transmitted by the electrostatic energy induced between the cell and the ground layer. Since the laminar structure is thin, the theoretical limit of energy consumption for signal transmission is smaller than that of radio transmission

under the same noise energy density. Another practical merit is that the cell bridge can be fabricated by a low cost CMOS process. It is also easy to embed the cell bridge function to various purposes of circuits.

The features of the proposed system are summarized as follows.

- High density network without long wires.
- Freedom on material selection. Stretchable sensor sheets can be realized.
- Secure communication with smaller power consumption compared with radio technology.

A cell bridge is especially effective when the cell can take on other functions. A flexible pressure sensor sheet is a good example of cell bridge application. Each cell can be used as a site of capacitive pressure-sensing element. Then the sheet is not only a pressure sensor sheet but also a communication medium with a large capacity.

We describe the physical layer and the data link layer of a cell bridge in OSI reference model. We develop the prototype of the cell bridge and mount them on stretchable fabrics. We also show the experimental results.

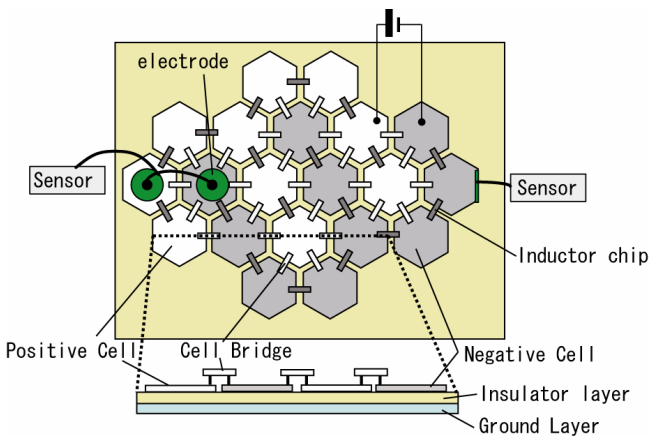

Fig. 2 Overview (upper) and cross-section (lower) of the proposed system.

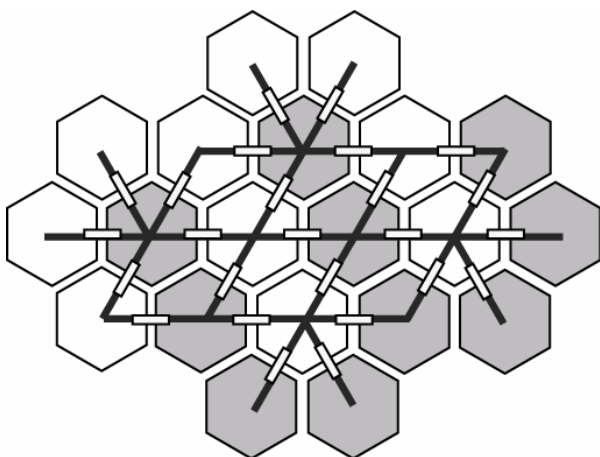

Fig. 3 The network topology of Fig. 2. The lines show the signal paths of the network in Fig. 2.

2. System Description

In this section, we explain the overview and the topology of the proposed system. Fig.2 shows the schematic diagram and the cross-section of the proposed system.

The proposed system consists of the following four kinds of elements.

● **Cell**
A cell is the medium where a cell bridge transmits signals. The half of all the cells is connected to a positive voltage source through inductor chips. We call them the “positive cells”. We call the other half “negative cells”. An appropriate configuration for the deployment of cell bridges and inductor chips is a hexagon. We can select various materials with low conductivity since the wide area transmits the signal current. In the experiment, cells are made of conductive fabrics.

● **Cell bridge**
A cell bridge transmits and receives signals through the cell. The power supply to the cell bridge is carried out by its connection to a neighbor positive cell and a negative cell.

● **Inductor chip**
Inductor chips maintain the positive and negative voltages of the cell in DC. At the signal frequency of the cell bridge, the inductors work as insulators.

● **Ground layer**
The ground layer is coupled with cells, and localizes the electrostatic energy in the space between the cells and the ground layer.

As Fig.2 shows, cell bridges and inductor chips are put between cells. The network is constructed without long wires and is expanded by the iteration of these structures. The energy to each cell bridge is supplied in DC. The routes where the signals can propagate are shown in Fig. 3.

There are two ways that an external element connects to the proposed system. One is mechanical and electrical contact to a cell through the same interface as a cell bridge. The other is to use capacitive proximity-coupling by a pair of electrodes that are put close to a pair of cells.

3. Physical Layer of Cell Bridge

In this section, we explain the physical layer of a cell bridge. How a cell bridge transmits signals through a cell to a neighbor cell bridge is presented, and we also show the property of the signal transmission.

A cell bridge transmits signals with two contacts to a pair of cells. When a cell bridge transmits a signal, the signal transmitted by the cell bridge is exclusively received by its neighbor cell-bridges sharing the same cell. Fig. 4 (a) shows the cross-section of the proposed system and Fig. 4 (b) shows the equivalent circuit of Fig. 4 (a).

The cell bridge functions as a resistor R when the cell bridge doesn't transmit signals as shown in Fig. 4 (a). And we assume the capacitance between the cell and the ground layer is C . When the center cell bridge in Fig. 4 transmits signals, the center cell bridge applies the voltage $V(t)$ between a pair of cells. Then if we assume the angular frequency ω satisfies

$$\frac{1}{C \cdot \omega} \ll R, \quad (1)$$

the voltage generated at cell 2 is $-V(t)/2$ while the voltage generated at cell 3 is $V(t)/2$. Thus the signals reach only to the cells the cell bridge connects. The neighbor cell bridges can receive the signals by observing the voltage between a pair of cells if the potentials of cell 1 and cell 4 don't change.

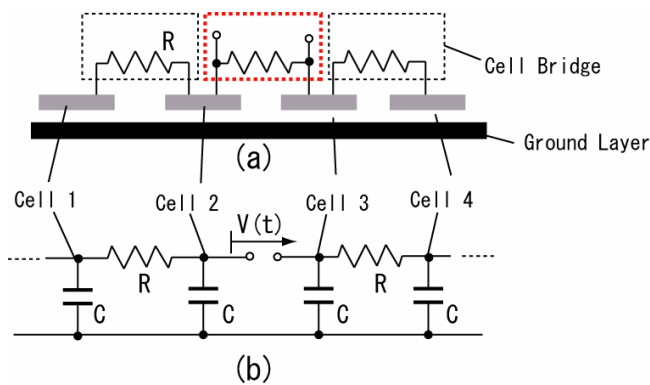

Fig. 4 (a) Cross-section of the proposed system. (b) Equivalent circuit of (a). When the center cell bridge transmits signals, signals don't propagate beyond the neighbor cell bridges. The neighbor cell bridges can receive signals by observing the voltage between the pair of cells.

The properties and required conditions for the signal transmission are summarized as follows.

- The transmitted signals reach to the both cells the cell bridge connects.
- When the cell bridge receives signals through one of two cells the cell bridge connects, the voltage of the other cell must be constant.
- When a cell bridge receives signals, a cell bridge cannot physically discriminate which of the two cells the signals come from. This is because the cell bridge observes the relative voltage between the cells.

4. Data Link Layer of Cell Bridge

In this section, we explain the protocol implemented on cell bridges. The basic design of collision avoidance partly follows the protocol of IEEE 802.11 [6]. The cell bridge system is different from the usual wireless sensor networks in the prerequisites as follows. First, in the cell bridge

system, the relative positions among the cell bridges do not change. Second, the boundary of the coverage is clearly defined. These are good news to make the protocol design easier. Third, the cell bridge has an extremely limited resource of memory. In our design, we allowed a memory space of only one packet on the cell-bridge chip to save the circuit area.

As a suitable protocol to the above mentioned conditions, the cell bridge cycles among the three states, (1) reception, (2) transmission and (3) observation. Reception and transmission are the state to receive a packet and to transmit a packet, respectively. In these states, the interaction between a transmitter and a receiver is based on the protocol of IEEE 802.11. The flow is shown in Fig. 5. In the state of observation, that is the state after transmission, a cell bridge detects the finish of the packet transmission beyond the coverage. That is carried out by observing the signal transmission by the neighbor cell bridge. Then the cell bridge enters the reception state.

In the cell bridge system, the route between a fixed communication pair is not changed frequently. Then one-directional data can be transmitted without loss by continuing the three-state cycle, with the one packet memory on the cell bridge. When other n pair's routes cross the route, the data source decreases the throughput to $1/(n+1)$ of the original throughput to avoid the congestions.

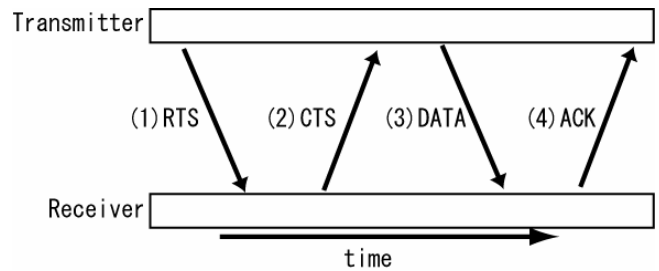

Fig. 5 The interaction between cell bridges in the states of transmission and reception. This is based on the protocol of IEEE 802.11. (1) A transmitter sends RTS (Request To Send) to require the permission of transmission. (2) A receiver sends CTS (Clear To Send) if it can receive a packet when receiving RTS. (3) Then the transmitter sends a packet after receiving CTS. (4) The receiver sends ACK (ACKnowledge) after receiving a packet.

5. Experiments and Results

We developed prototype LSI chips for a cell bridge. Fig. 6 (a) shows the expanded photo of the developed LSI chip based on $0.35 \mu\text{m}$ CMOS process and Fig. 6 (b) shows a cell bridge with the LSI chip. The length of the side of the LSI chip with analog-digital mixed circuits is 5 mm. The length of the digital circuit core is about 1.1mm. The operating frequency of the LSI chip is designed to be 50MHz. In the current protocol, we tolerate 10 % of the clock-frequency difference between a transmitter and a receiver. The difference is compensated by signal sampling of 16 phases in one clock period. Then the chip requires no clock standard outside of the CMOS circuit.

We examined the behavior of a single chip first and then we constructed the network system and evaluated the performance of it.

Fig. 7 shows the waveform of the clock oscillation in a cell bridge. The average frequency of the clock was 55.6 MHz.

The network sheet with prototype cell bridges is shown in Fig. 8. Cells and insulators are made of stretchable fabrics. The thickness and the sheet resistance of the cell is 225 μm and 3.0 Ω , respectively. The length of the side of a cell is 20 cm. Two cell bridges are mounted between the cells. PCs are connected to the network. The cross-section of the network system constructed with prototype cell bridges are shown in Fig. 9. The laminar structure of the system consists of cells, a ground layer and a power layer. The prototype cell bridge is supplied with the power by contacting a ground layer and a power layer. In the current stage, the structure is not faithful to the design goal as shown in Fig. 2, in which the cell bridge has only two electrical contacts on a single layer of the sheet.

The experiment was that the source PC transmitted the data to the destination PC through the network by two hopping. We measured the basic performance of the network, throughput, bit error rate, delay and so on.

Fig. 10 shows the waveforms at the instance of the signal transmission between cell bridges. The line of CH3 means the receiver's waveform and the line of CH4 means the transmitter's waveform. The change of the waveform in CH3 means the part of CTS that shows the receiver is ready to receive a packet. The change of the waveform in CH4 means the packet data is transmitted, and Fig. 10 shows the packet data is transmitted after the receiver transmitted CTS.

The specification of a cell bridge and the experimental condition and results are showed in Table1. Throughput between PCs is about 2Mbps. Bit error rate is less than 0.0003 % and Disappearance rate of packets is about 0.00025 %. This data means the proposed method is capable of high-speed and high-quality communication. The power consumption is 247.5mW (waiting) and 330mW (in communication). In this stage, the signal amplitude is unnecessarily large compared to the environmental noise amplitude. Minimizing the power consumption is a future work.

Since the cells and the insulators are made of stretchable fabrics, this network sheet is stretchable as shown in Fig. 11. When we stretched this sheet in the signal transmission, the stretching didn't affect the communication.

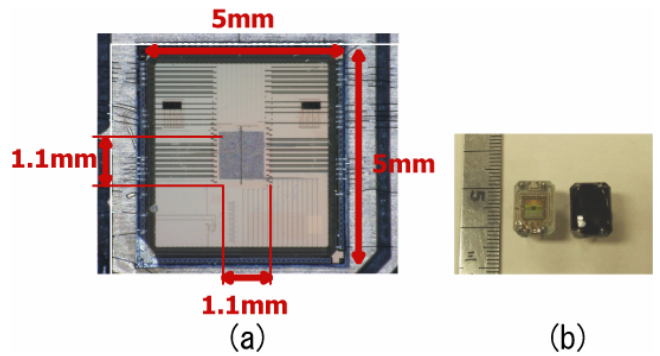

Fig. 6 (a) The photo of the developed LSI chip (a) and the cell bridge (b).

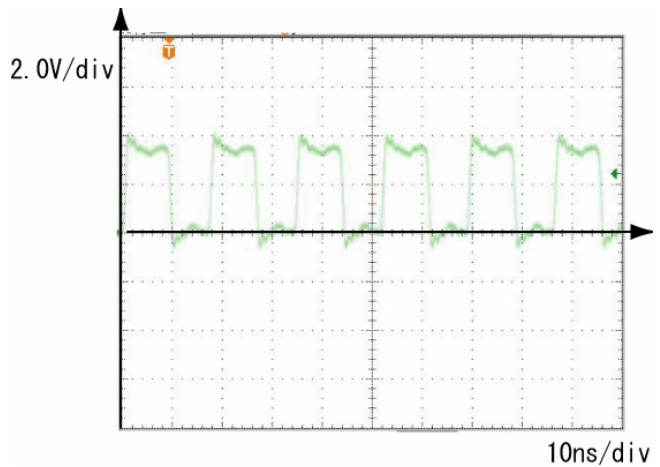

Fig. 7 The waveform of the clock oscillation of a prototype cell bridge. The average operating frequency of the chip is 55.6 MHz.

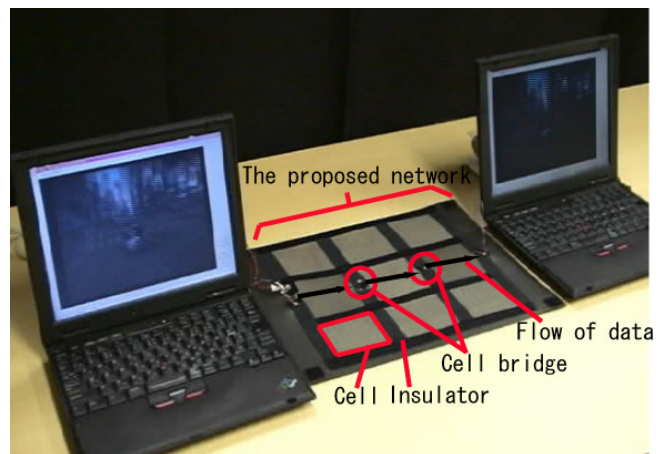

Fig. 8 The experimental system. The matrix between the PCs is the proposed system. The cell bridge is connected between the cells.

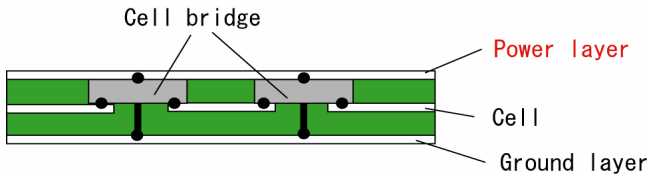

Fig. 9 The cross-section of the network system constructed with prototype cell bridges and cells. The prototype cell bridge gets the power by connecting to the power layer and the ground layer. (This structure is not faithful to that of Fig. 2.)

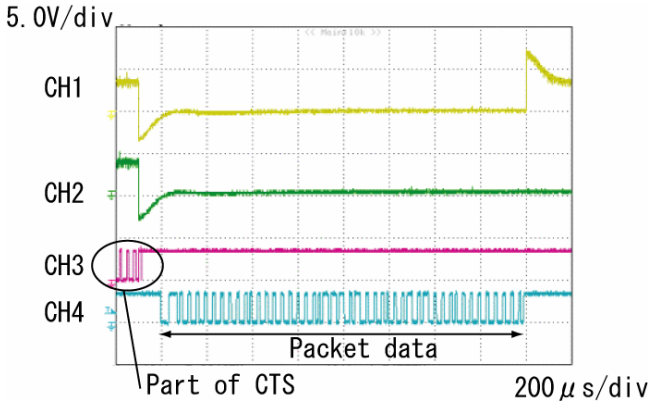

Fig. 10 The waveform during the communication. The purple line is the receiver’s waveform. The blue line is the transmitter’s. Packet data is transmitted after CTS is transmitted.

Table 1 The specification of a cell bridge.

Specification of cell bridge	
Operating frequency	55.6 MHz
Instant throughput F	55.6 Mbps
Condition of measurement	
Transmitted data size	16,692,868byte
Packet size B	245 bit
Data size per a packet	116 bit
The number of transmitted packets	1,192,348
The number of hopping N	2
Results (average)	
Total transmission time T	60.5s
Throughput between nodes	2,152 kbps
Delay time NB/F	8.81 μs
Bit Error rate	Less than 0.0003 %
Packet loss rate	0.00025 %
Power consumption	247.5mW(waiting) 330mW(in communication)



Fig. 11 A scene of the experiment. The cell bridges are mounted on stretchable conductive fabrics. Stretching didn’t affect the communication.

6. Summary

In this paper, we proposed “cell bridge” which is the communication element and a network system using it. The network system is constructed by combining multiple two-dimensional areas called “cells” with cell bridges. We described the principle of the cell bridge system and developed a prototype cell bridge based on CMOS technology. And we made a stretchable network sheet with cell bridges. The experimental results showed the proposed system is capable of high-speed signal transmission.

By putting cell bridges at the boundaries of cells, we can construct a network, and we can extend the network by iterating the structure. The packet is transferred by multi-hopping through multiple cell bridges with neither electromagnetic wave radiation nor long wires. We can construct high-density sensor sheet on various materials and endow it with the function of communication medium. The power consumption is expected to be lower than radio technology.

Acknowledgement

We thank Naoya Asamura, Tachio Yuasa, Mitsuhiro Hakozaki, and Xinyu Wang, Cellcross Co., Ltd. for their cooperation on fabricating and evaluating the prototype, and providing ideas on device structures and their applications.

References

- [1] J. Elson, and K. Romer, “Wireless Sensor Networks: A New Regime for Time Synchronization,” HotNets-1, Oct 2002.
- [2] J. Elson, and K. Romer, “Wireless Sensor Networks: A New Regime for Time Synchronization,” HotNets-1, Oct 2002.

- [3] S. Ando and N. Ono, "A Bayesian theory of cooperative calibration and synchronization in sensor networks," Proc. INSS'04, pp.66-71, Tokyo, 2004.
- [4] Y.-C. Tseng, S.-Y. Ni, Y.-S. Chen, and J.-P. Sheu, "The Broadcast Storm Problem in a Mobile Ad Hoc Network," CAIP Technical Report 248, Rutgers Univ., Sept. 2000.
- [5] S. Megerian, F. Koushanfar, M. Potkonjak and M.B. Srivastava, "Worst and Best-Case Coverage in Sensor Networks," IEEE Trans. Mobile and Computing, vol.4, pp.84-92, Jan/Feb. 2005
- [6] V. Mehta and M.E. Zarki, "A Bluetooth Based Sensor Network for Civil Infrastructure Health Monitoring," Wirelee Networks, 10, 401-412, 2004
- [7] Andrew S. Tanenbaum, Computer Networks Fourth Edition, Person Education International, 2003.
- [8] H.Shinoda, N.Asamura, T.Yuasa, M.Hakozaki, X.Wang, H.Itai, Y.Makino and A.Okada, "Two Dimensional Communication Technology Inspired by Robot Skin", Proc.IEEE TExCRA 2004 (Technical Exhibition BasedConf. on Robotics and Automation), pp99-100, 2004.LII